

# 4SR

## 4" submersible pumps

-  Clean water  
(Maximum sand content 150 g/m<sup>3</sup>)
-  Domestic use
-  Civil use
-  Industrial use



### PERFORMANCE RANGE

- Flow rate up to **340 l/min** (20.4 m<sup>3</sup>/h)
- Head up to **405 m**

### APPLICATION LIMITS

- Maximum liquid temperature **+35 °C**
- Maximum sand content **150 g/m<sup>3</sup>**
- **100 m** immersion limit
- Installation:
  - vertical
  - horizontal, with the following limits:
    - 4SR1 - 4SR1.5 - 4SR2 - 4SR4 up to **27 stages**
    - 4SR6 - 4SR8 up to **17 stages**
    - 4SR10 - 4SR12 - 4SR15 up to **12 stages**
- Starts/hour: **20** at regular intervals
- Minimum flow rate for motor cooling **8 cm/s**
- Continuous service **S1**

### CONSTRUCTION AND SAFETY STANDARDS

#### ELECTRIC MOTOR

- Single-phase 230 V - 50 Hz
- Three-phase 400 V - 50 Hz

Length of power cable:

- **2 m** powers from 0.37 to 2.2 kW
- **3.6 m** powers from 3 to 7.5 kW.

EN 60335-1      EN 60034-1  
IEC 60335-1      IEC 60034-1  
CEI 61-150        CEI 2-3



EU REGULATION N. 547/2012

### CERTIFICATIONS

Company with management system certified DNV  
ISO 9001: QUALITY  
ISO 14001: ENVIRONMENT



### INSTALLATION AND USE

Suitable for use with clean water with a sand content of no more than **150 g/m<sup>3</sup>**. Because of their high efficiency and reliability, they are suitable for use in domestic, civil and industrial applications such as for the distribution of water in combination with pressure tanks, for irrigation, for washing plants and for pressure boosting in fire-fighting sets, etc.

### PATENTS - TRADE MARKS - MODELS

- Patent n. EP2419642

### OPTIONS AVAILABLE ON REQUEST

- Other voltages or 60 Hz frequency
- **Kit of cooling jacket complete with filter and supports**



**PERFORMANCE RANGE**

50 Hz n= 2900 min<sup>-1</sup>

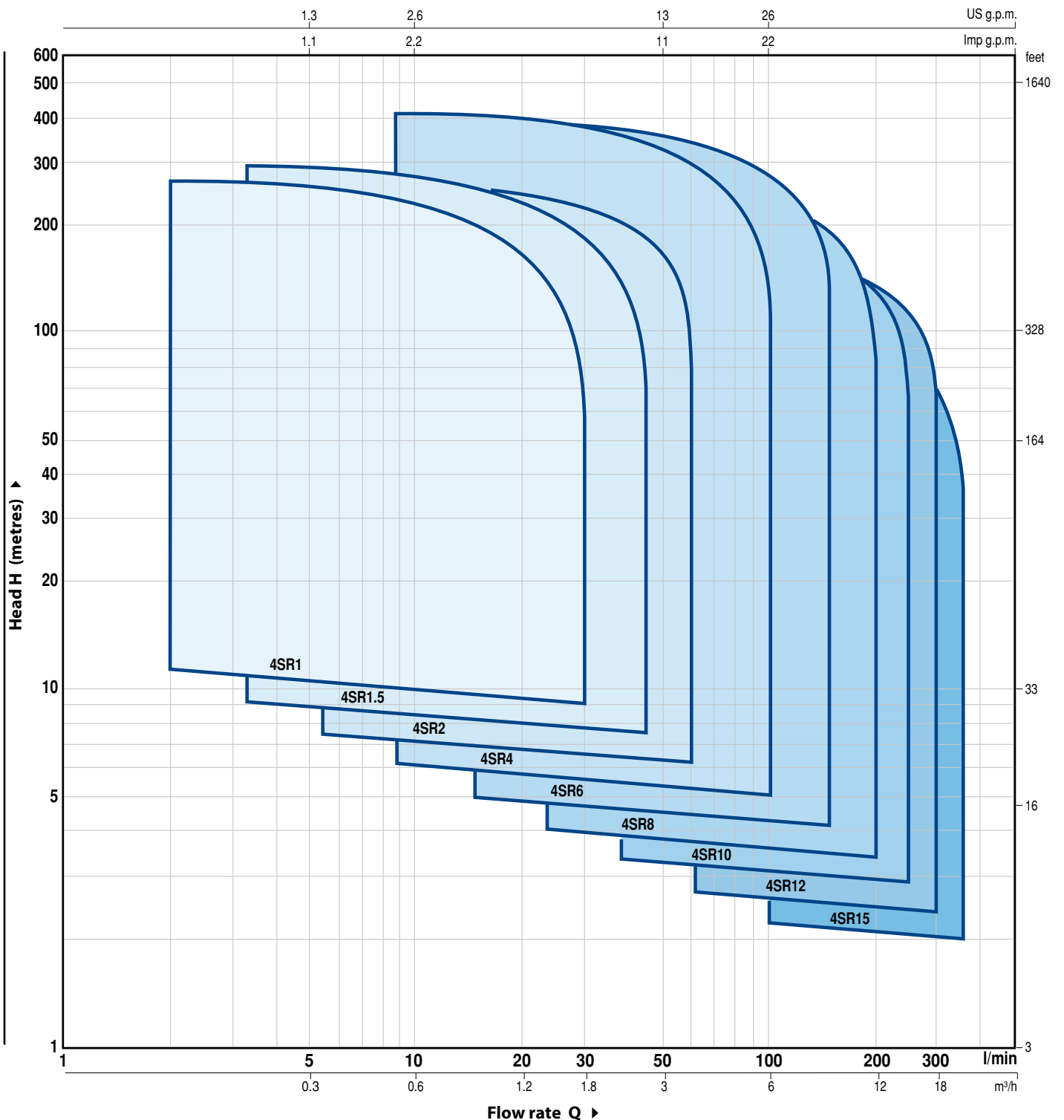

**NOMENCLATURE**

**4 SR 1 m / 13 - PD or PS or HYD**

- Borehole diameter in inches \_\_\_\_\_
- Series \_\_\_\_\_
- Flow rate in m<sup>3</sup>/h at the point of highest efficiency \_\_\_\_\_
- Single-phase motor \_\_\_\_\_
- Number of stages \_\_\_\_\_
- PD:** pump with "4PD PEDROLLO" motor \_\_\_\_\_
- PS:** pump with "4PS PEDROLLO" motor \_\_\_\_\_
- HYD:** pump without motor \_\_\_\_\_

# 4SR1

## CHARACTERISTIC CURVES AND PERFORMANCE DATA

50 Hz n= 2900 min<sup>-1</sup>

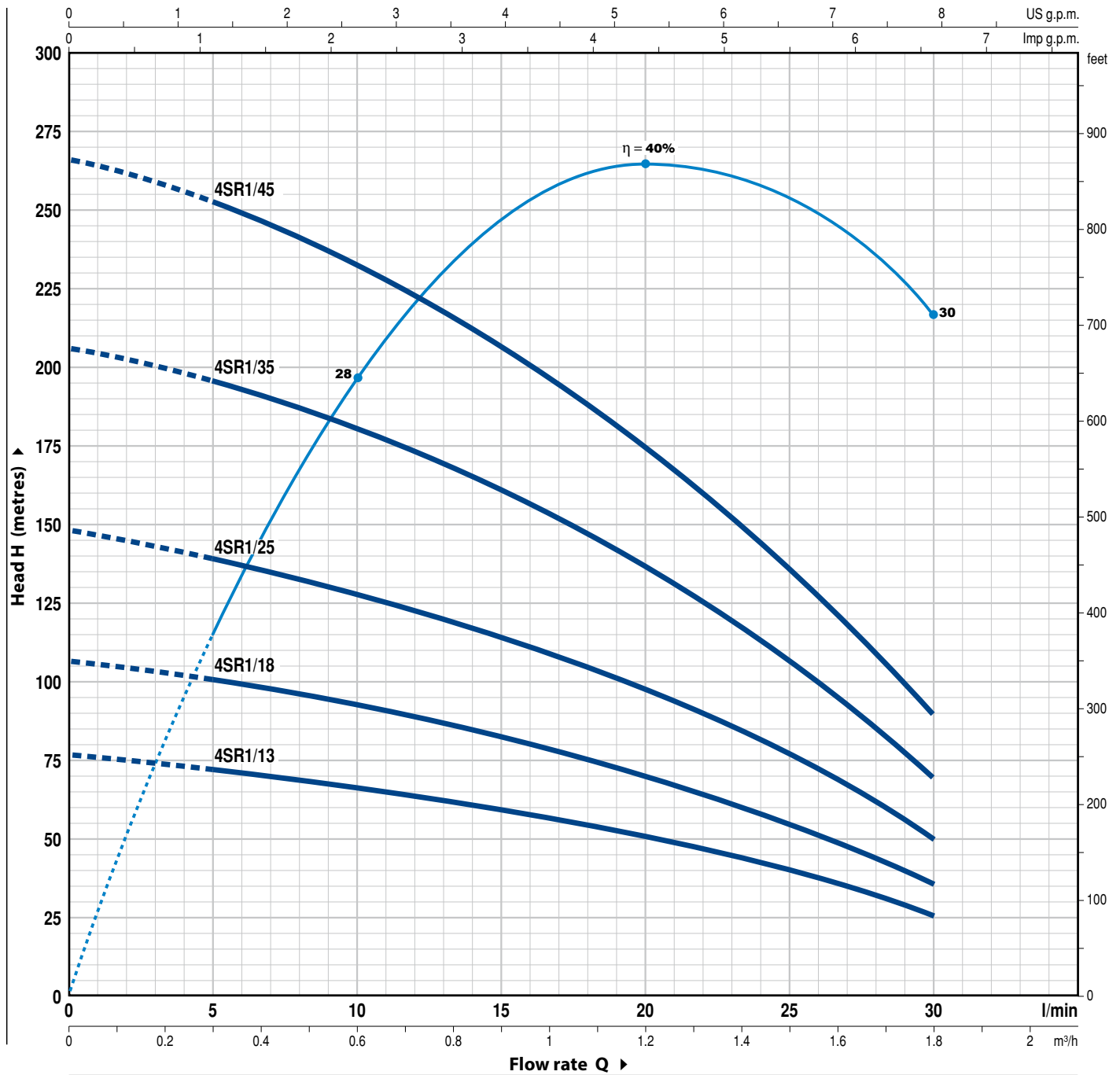

MODEL		POWER (P <sub>2</sub> )		Q	Flow rate (l/min)						
Single-phase	Three-phase	kW	HP		0	5	10	15	20	25	30
4SR1m/13	4SR1/13	0.37	0.50	H metres	77	73	67	60	51	40	26
4SR1m/18	4SR1/18	0.55	0.75		107	101	93	83	71	55	36
4SR1m/25	4SR1/25	0.75	1		148	140	129	115	98	77	50
4SR1m/35	4SR1/35	1.1	1.5		206	197	182	161	136	107	70
4SR1m/45	4SR1/45	1.5	2		266	254	234	207	176	137	90

Q = Flow rate H = Total manometric head

Tolerance of characteristic curves in compliance with EN ISO 9906 Grade 3B.

## CHARACTERISTIC CURVES AND PERFORMANCE DATA

50 Hz n = 2900 min<sup>-1</sup>

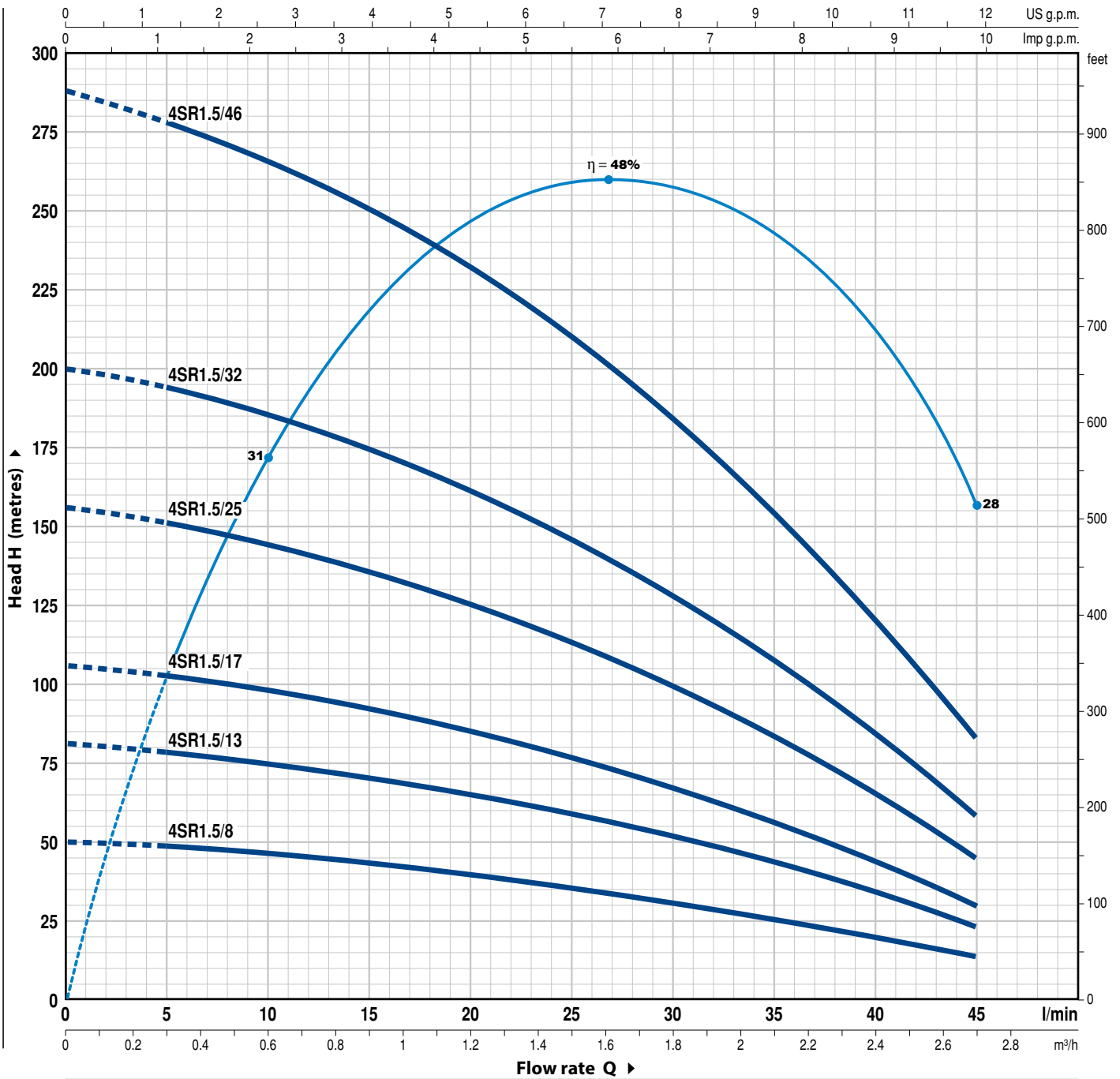

MODEL		POWER (P <sub>2</sub> )		Q	H metres												
Single-phase	Three-phase	kW	HP		m <sup>3</sup> /h	0	0.3	0.6	0.9	1.2	1.5	1.8	2.1	2.4	2.7		
				l/min	0	5	10	15	20	25	30	35	40	45			
4SR1.5m/8	4SR1.5/8	0.37	0.50	H metres	50	48	46	44	40	36	32	26	20	14			
4SR1.5m/13	4SR1.5/13	0.55	0.75		81	78	75	71	66	59	52	43	33	23			
4SR1.5m/17	4SR1.5/17	0.75	1		106	102	98	93	86	78	68	56	43	30			
4SR1.5m/25	4SR1.5/25	1.1	1.5		156	151	144	136	127	115	100	83	64	45			
4SR1.5m/32	4SR1.5/32	1.5	2		200	193	184	175	162	147	128	106	82	58			
4SR1.5m/46	4SR1.5/46	2.2	3		288	277	265	250	233	211	184	153	117	83			

Q = Flow rate H = Total manometric head

Tolerance of characteristic curves in compliance with EN ISO 9906 Grade 3B.

# 4SR2

## CHARACTERISTIC CURVES AND PERFORMANCE DATA

50 Hz n= 2900 min<sup>-1</sup>

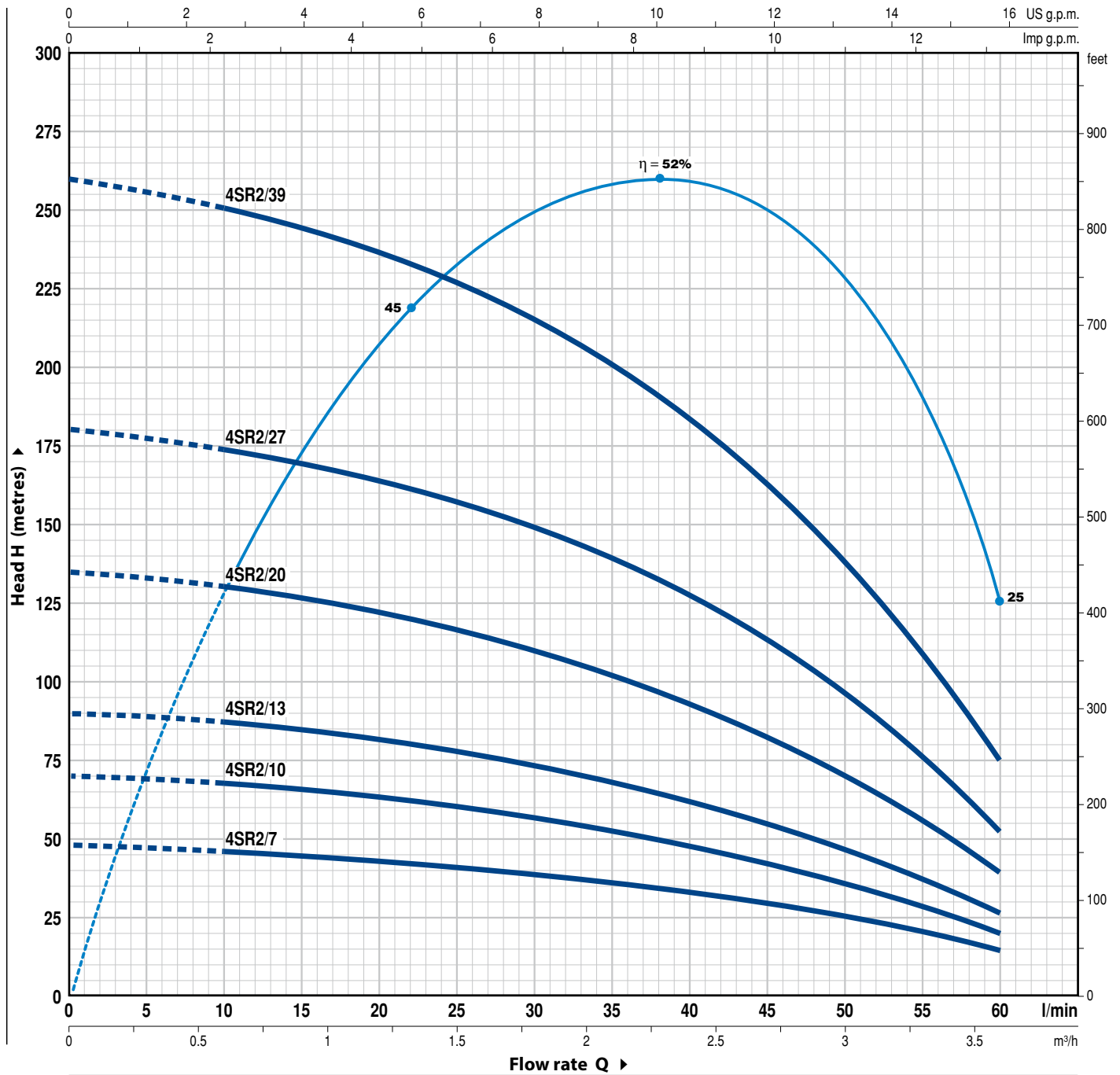

MODEL		POWER (P <sub>2</sub> )		Q	0	0.6	1.2	1.8	2.4	3.0	3.6
Single-phase	Three-phase	kW	HP								
4SR2m/7	4SR2/7	0.37	0.50	H metres	0	10	20	30	40	50	60
4SR2m/10	4SR2/10	0.55	0.75		48	46	44	39	33	25	14
4SR2m/13	4SR2/13	0.75	1		70	68	63	57	48	36	20
4SR2m/20	4SR2/20	1.1	1.5		90	88	82	74	62	46	26
4SR2m/27	4SR2/27	1.5	2		135	130	122	111	93	71	39
4SR2m/39	4SR2/39	2.2	3		180	173	164	150	126	96	52
					260	250	238	216	183	138	75

Q = Flow rate H = Total manometric head

Tolerance of characteristic curves in compliance with EN ISO 9906 Grade 3B.

## CHARACTERISTIC CURVES AND PERFORMANCE DATA

50 Hz n = 2900 min<sup>-1</sup>

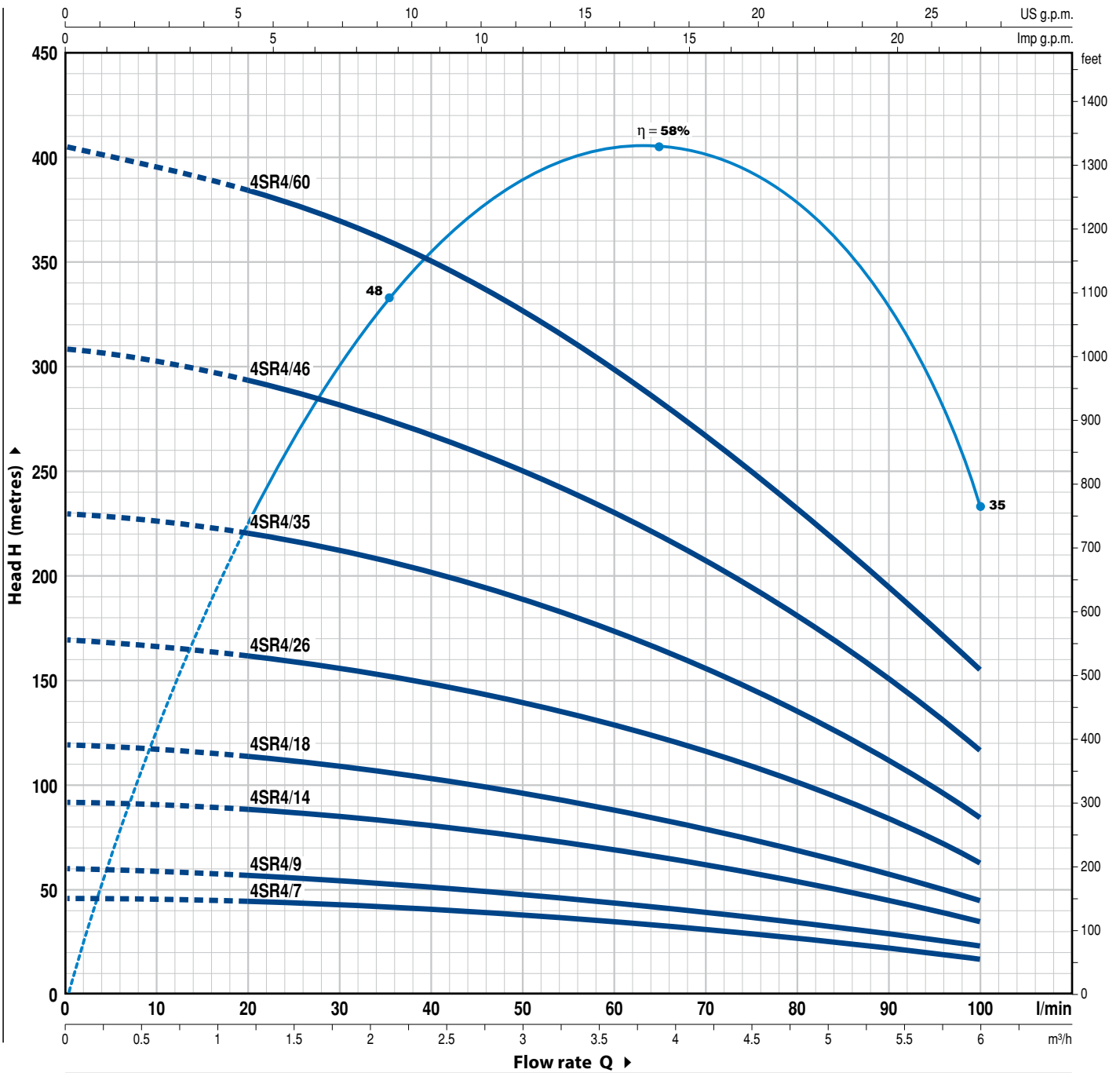

MODEL		POWER (P <sub>2</sub> )		Q	Flow rate (l/min)										
Single-phase	Three-phase	kW	HP		0	1.2	1.8	2.4	3.0	3.6	4.2	4.8	5.4	6.0	
4SR4m/7	4SR4/7	0.55	0.75	H metres	46	44	42	40	38	35	32	28	23	17	
4SR4m/9	4SR4/9	0.75	1		60	56	55	52	49	45	40	35	29	23	
4SR4m/14	4SR4/14	1.1	1.5		92	88	85	81	76	70	63	55	45	35	
4SR4m/18	4SR4/18	1.5	2		120	112	109	104	98	90	81	70	58	45	
4SR4m/26	4SR4/26	2.2	3		170	162	157	150	141	130	116	101	84	63	
-	4SR4/35	3	4		230	220	211	202	190	175	157	137	113	85	
-	4SR4/46	4	5.5		308	293	280	269	249	230	205	181	151	117	
-	4SR4/60	5.5	7.5		405	385	370	350	325	300	270	235	195	155	

Q = Flow rate H = Total manometric head

Tolerance of characteristic curves in compliance with EN ISO 9906 Grade 3B.

# 4SR6

## CHARACTERISTIC CURVES AND PERFORMANCE DATA

50 Hz n= 2900 min<sup>-1</sup>

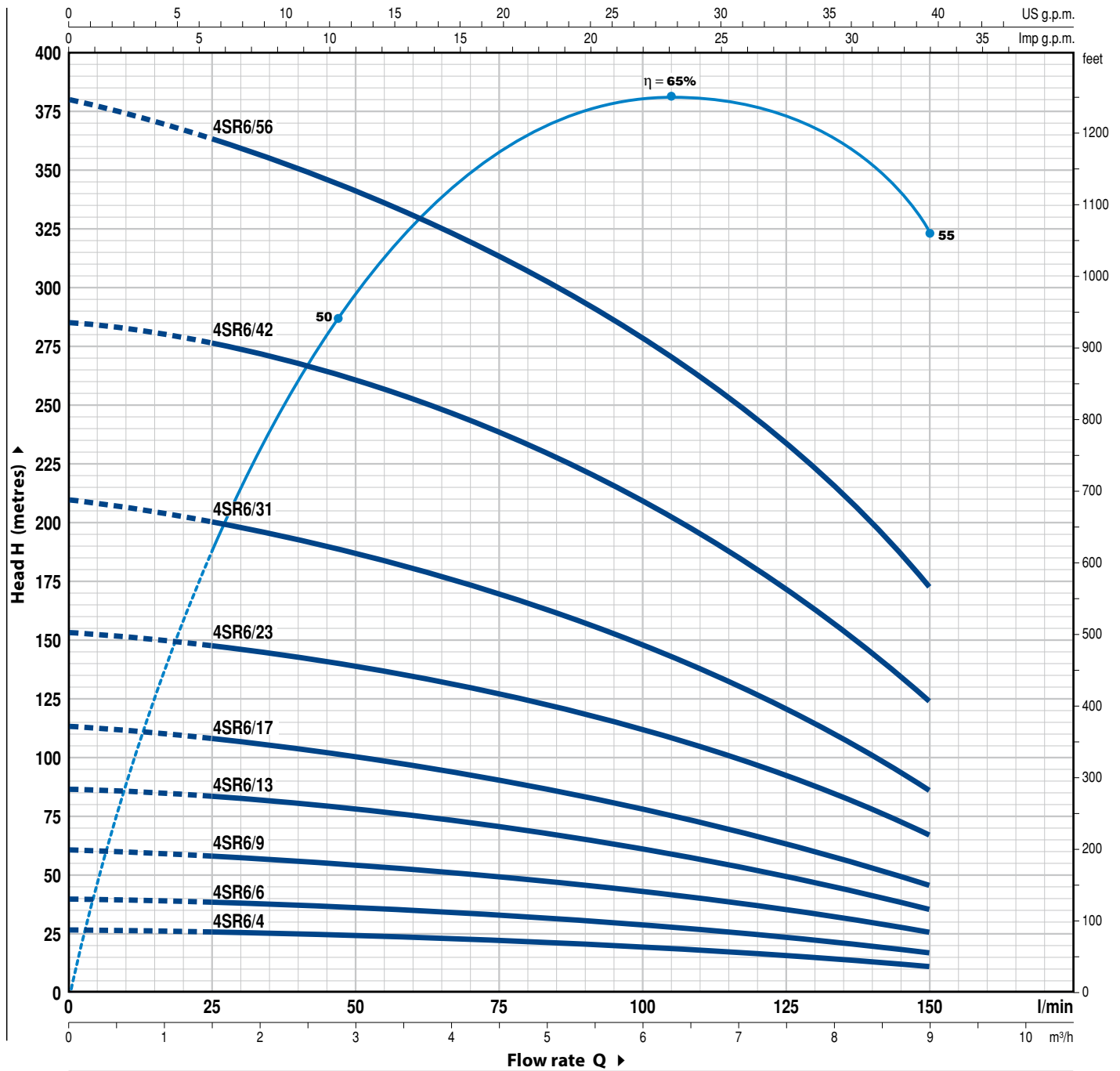

MODEL		POWER (P <sub>2</sub> )		Q	Flow rate (l/min)						
Single-phase	Three-phase	kW	HP		0	1.5	3.0	4.5	6.0	7.5	9.0
4SR6m/4	4SR6/4	0.55	0.75	H metres	0	25	50	75	100	125	150
4SR6m/6	4SR6/6	0.75	1		27	26	24	22	19	15	11
4SR6m/9	4SR6/9	1.1	1.5		40	38	36	33	29	24	17
4SR6m/13	4SR6/13	1.5	2		61	58	54	50	44	35	26
4SR6m/17	4SR6/17	2.2	3		87	83	78	71	61	49	35
-	4SR6/23	3	4		114	107	100	91	79	62	45
-	4SR6/31	4	5.5		154	148	138	128	112	92	67
-	4SR6/42	5.5	7.5		210	200	186	170	149	121	86
-	4SR6/56	7.5	10		285	276	258	240	212	170	124
-	4SR6/56	7.5	10		380	365	340	315	280	233	173

Q = Flow rate H = Total manometric head

Tolerance of characteristic curves in compliance with EN ISO 9906 Grade 3B.

## CHARACTERISTIC CURVES AND PERFORMANCE DATA

50 Hz n = 2900 min<sup>-1</sup>

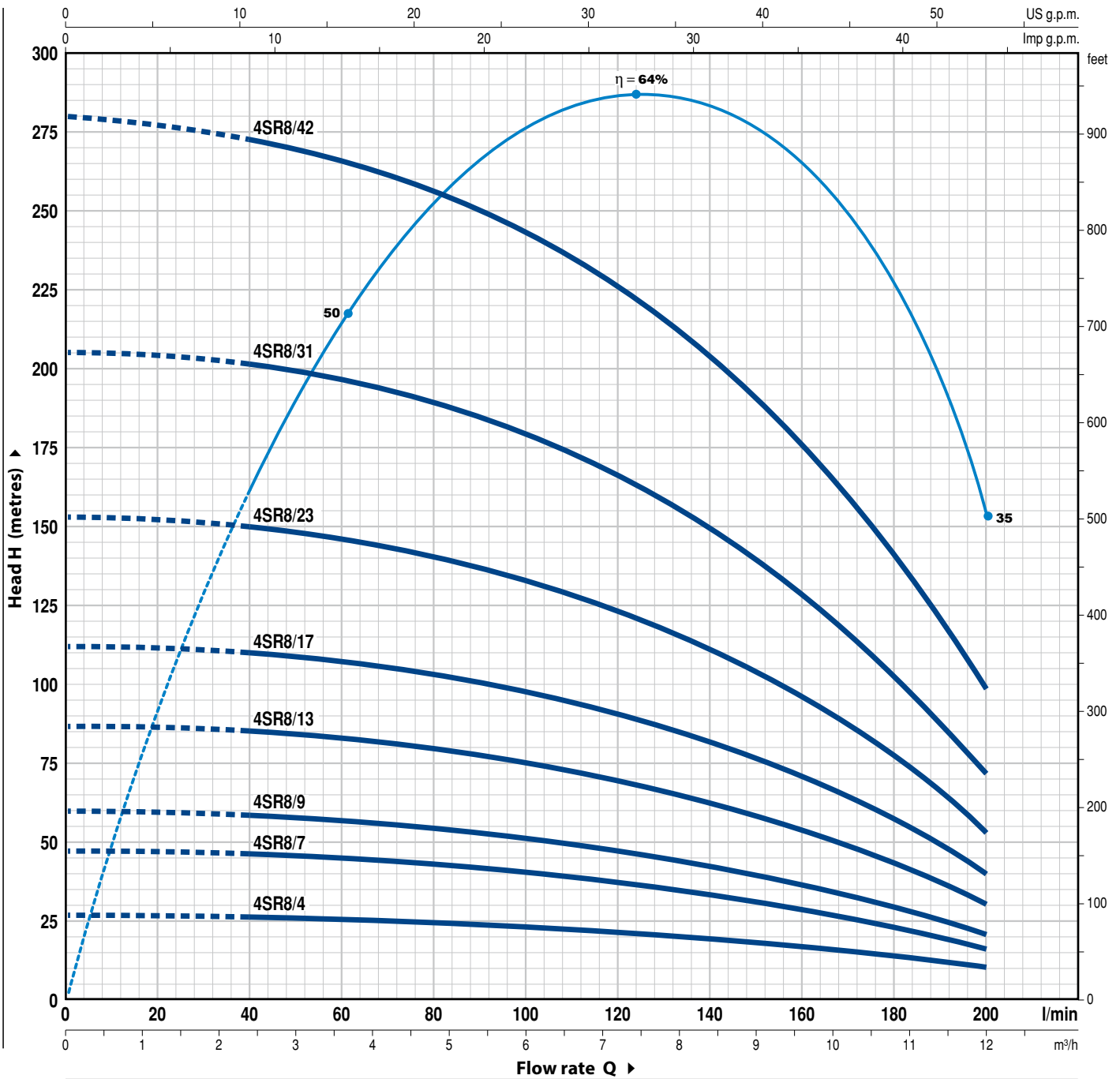

MODEL		POWER (P <sub>2</sub> )		Q	Flow rate (l/min)												
Single-phase	Three-phase	kW	HP		0	2.4	3.6	4.8	6.0	7.2	8.4	9.6	10.8	12.0			
4SR8m/4	4SR8/4	0.75	1	H metres	0	40	60	80	100	120	140	160	180	200			
4SR8m/7	4SR8/7	1.1	1.5		27	26	25	24	23	22	20	17	13	10			
4SR8m/9	4SR8/9	1.5	2		47	46	45	43	41	38	34	29	23	16			
4SR8m/13	4SR8/13	2.2	3		60	58	57	55	52	48	43	37	30	21			
-	4SR8/17	3	4		87	85	83	80	76	70	63	54	43	30			
-	4SR8/23	4	5.5		112	110	108	104	99	92	82	70	56	40			
-	4SR8/31	5.5	7.5		153	150	146	141	134	124	111	95	76	53			
-	4SR8/42	7.5	10		205	200	196	190	181	167	149	128	103	72			
					280	272	266	257	244	225	202	175	140	98			

Q = Flow rate H = Total manometric head

Tolerance of characteristic curves in compliance with EN ISO 9906 Grade 3B.



# 4SR10

## CHARACTERISTIC CURVES AND PERFORMANCE DATA

50 Hz n= 2900 min<sup>-1</sup>

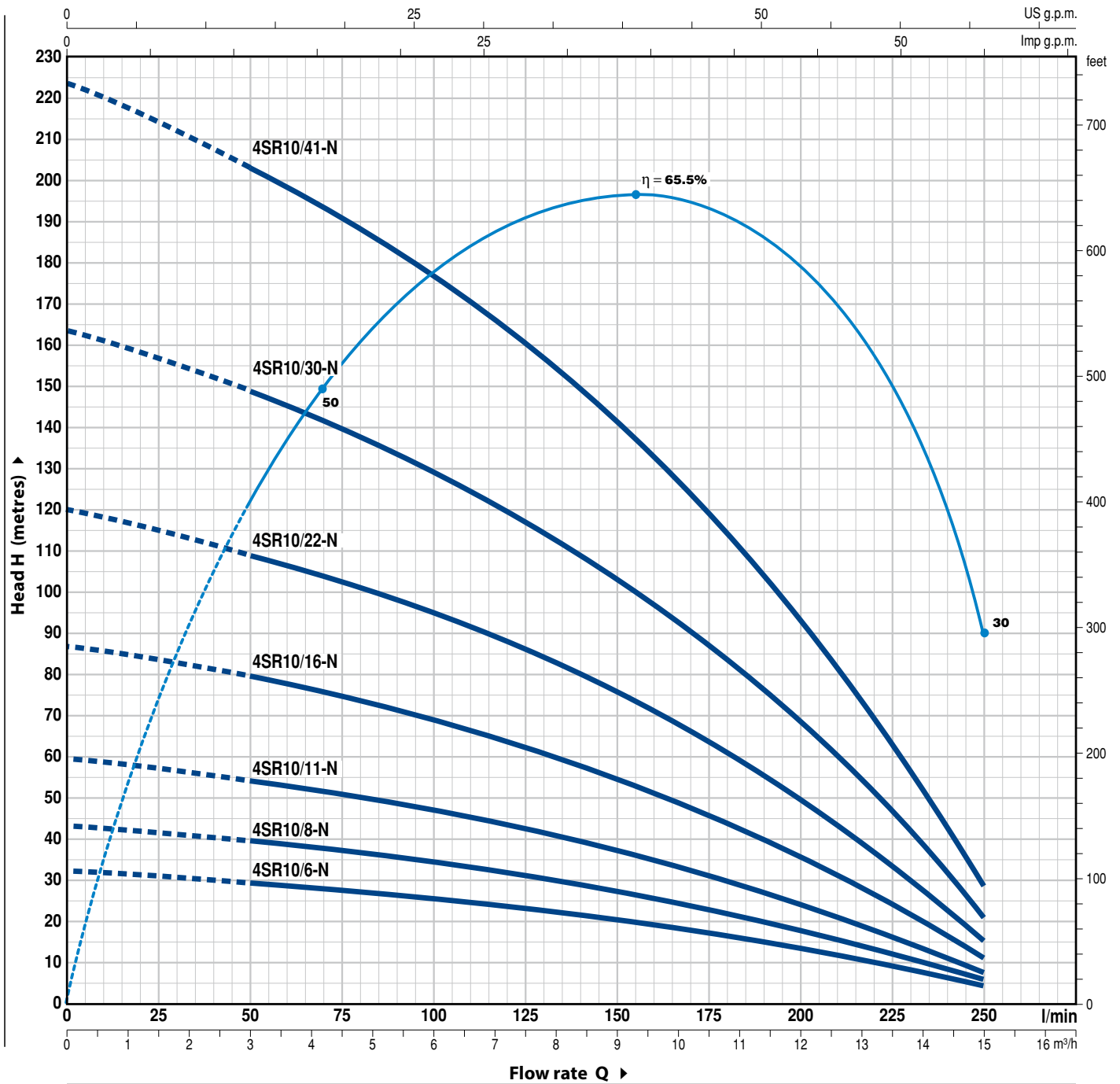

MODEL		POWER (P <sub>2</sub> )		Q	Flow rate (l/min)									
Single-phase	Three-phase	kW	HP		0	3.0	6.0	7.5	9.0	10.5	12	13.5	15.0	
4SR10m/6 -N	4SR10/6 -N	0.75	1	H metres	33	29	25	23	20.5	17	13.5	9	4	
4SR10m/8 -N	4SR10/8 -N	1.1	1.5		43	39	35	31	27.5	23	18	12	6	
4SR10m/11 -N	4SR10/11 -N	1.5	2		60	54	47	42	37.5	31	25	16.5	8	
4SR10m/16 -N	4SR10/16 -N	2.2	3		87	79	69	62	55	45	36.5	24	11	
-	4SR10/22 -N	3	4		120	109	95	85	76	63	50	33	15	
-	4SR10/30 -N	4	5.5		163	148	129	116	103	86	68	45	21	
-	4SR10/41 -N	5.5	7.5		223	203	176	159	141	117	93	61.5	29	

Q = Flow rate H = Total manometric head

Tolerance of characteristic curves in compliance with EN ISO 9906 Grade 3B.

## CHARACTERISTIC CURVES AND PERFORMANCE DATA

50 Hz n= 2900 min<sup>-1</sup>

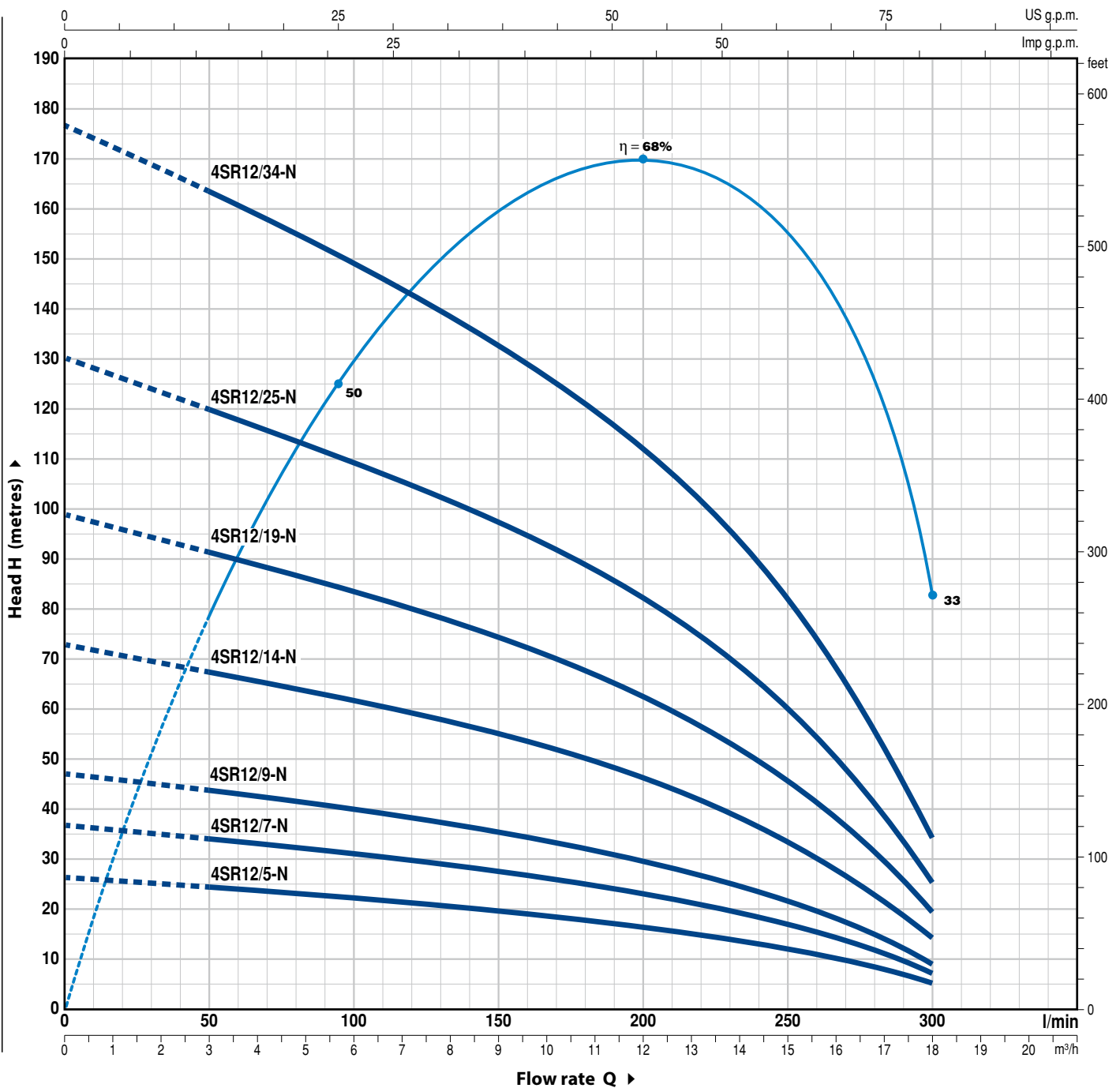

MODEL		POWER (P <sub>2</sub> )		Q	Flow rate (l/min)													
Single-phase	Three-phase	kW	HP		0	3.0	6.0	8.4	10.2	12	13.8	15.6	16.8	18.0				
4SR12m/5 -N	4SR12/5 -N	0.75	1	H metres	26	24	22	20	18.5	16.5	14	10.7	8	5				
4SR12m/7 -N	4SR12/7 -N	1.1	1.5		36.5	33.5	30.7	28	25.8	23.2	19.7	15	11.3	7				
4SR12m/9 -N	4SR12/9 -N	1.5	2		47	43	39.5	36	33	29.8	25.5	19.3	14.5	9				
4SR12m/14 -N	4SR12/14 -N	2.2	3		73	67	61.3	56	51.5	46.3	39.5	30	22.5	14				
-	4SR12/19 -N	3	4		99	91	83.2	76	70	63	53.5	40.7	30.5	19				
-	4SR12/25 -N	4	5.5		130	120	109.5	100	92	82.8	70.5	53.5	40.3	25				
-	4SR12/34 -N	5.5	7.5		177	163	149	136	125	112.5	95	72.8	54.7	34				

Q = Flow rate H = Total manometric head

Tolerance of characteristic curves in compliance with EN ISO 9906 Grade 3B.

# 4SR15

## CHARACTERISTIC CURVES AND PERFORMANCE DATA

50 Hz n= 2900 min<sup>-1</sup>

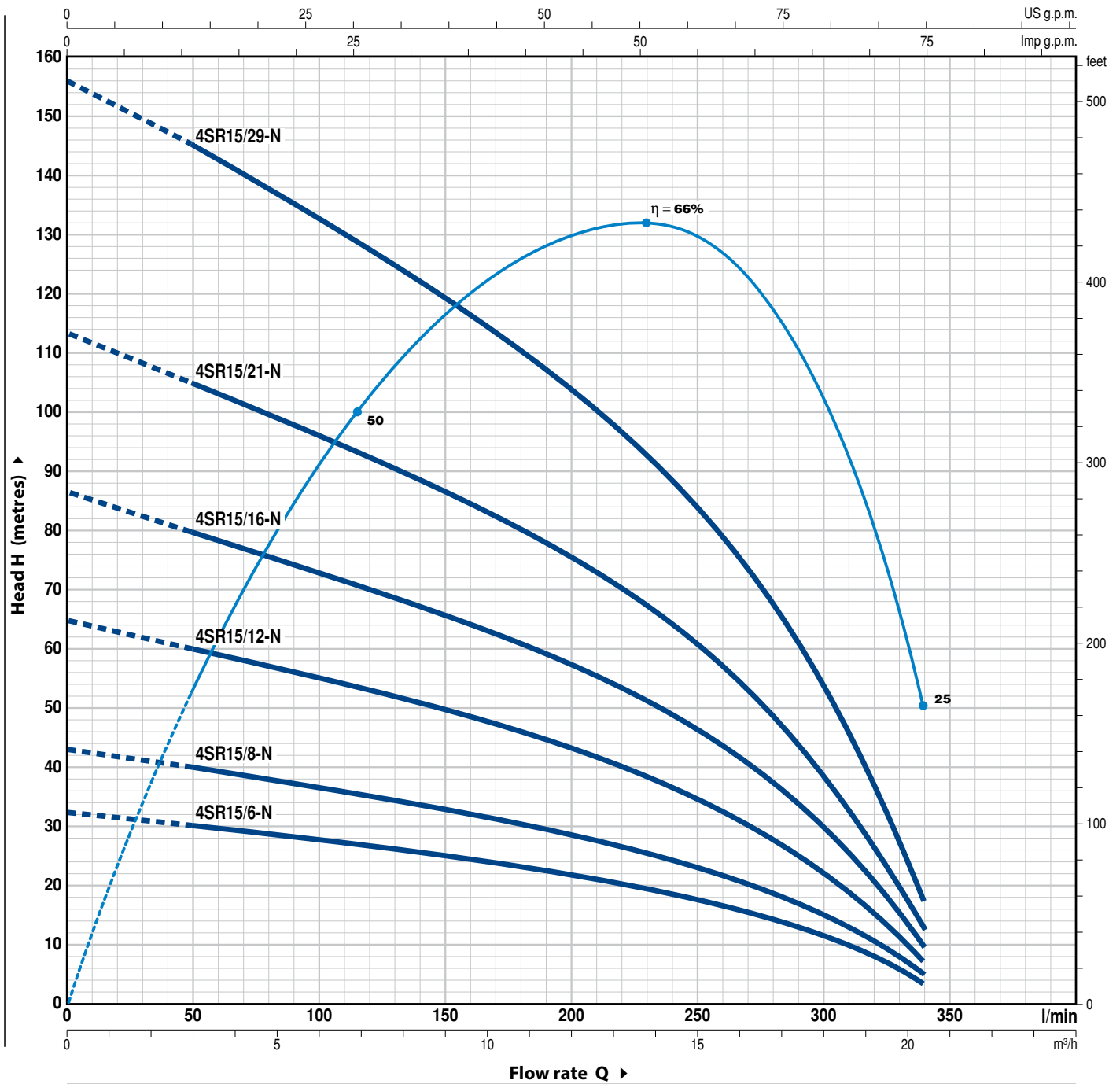

MODEL		POWER (P <sub>2</sub> )		Q	Flow rate (l/min)									
Single-phase	Three-phase	kW	HP		0	3.0	6.0	9.0	12	15	18	19.2	20.4	
4SR15m/6 -N	4SR15/6 -N	1.1	1.5	H metres	0	50	100	150	200	250	300	320	340	
4SR15m/8 -N	4SR15/8 -N	1.5	2		32	30	27.5	24.5	21.5	17.5	11	7.5	3	
4SR15m/12 -N	4SR15/12 -N	2.2	3		43	40	36.5	32.5	28.5	23.5	14.5	10	5	
-	4SR15/16 -N	3	4		64	60	54.5	49	43	35	22	15	7	
-	4SR15/21 -N	4	5.5		86	80	73	65.5	57.5	46.5	29.5	20.5	9	
-	4SR15/29 -N	5.5	7.5		113	105	95.5	86	75.5	61	38.5	26.5	12	
					156	145	132	119	104.5	84.5	53	37	17	

Q = Flow rate H = Total manometric head

Tolerance of characteristic curves in compliance with EN ISO 9906 Grade 3B.

## POS. COMPONENT

## CONSTRUCTION CHARACTERISTICS

<b>1 DELIVERY BODY</b>	Precision cast stainless steel AISI 304 complete with threaded delivery port in compliance with ISO 228/1
<b>2 NON-RETURN VALVE</b>	Stainless steel AISI 304
<b>3 MOTOR BRACKET</b>	Stainless steel AISI 304 in compliance with NEMA standards
<b>4 IMPELLER</b>	Lexan 141-R for 4SR1-1.5-2-4-6-8 Noryl FE1520PW for 4SR10-12-15
<b>5 DIFFUSER</b>	Noryl FE1520PW
<b>6 STAGE CASING</b>	Stainless steel AISI 304
<b>7 PUMP SHAFT</b>	Stainless steel AISI 304
<b>8 PUMP BEARINGS</b>	Special technopolymer housing with stainless steel AISI 316, chrome oxide coated, sand resistant shaft bushing
<b>9 DRIVE COUPLING</b>	Stainless steel AISI 316L up to 2.2 kW; stainless steel AISI 304 for higher powers
<b>10 FILTER</b>	Stainless steel AISI 304
<b>11 CABLE COVER</b>	Stainless steel AISI 304
<b>12 MOTOR 4"</b>	<b>4PD</b> = "PEDROLLO" oil filled motor <b>4PS</b> = "PEDROLLO" water filled motor

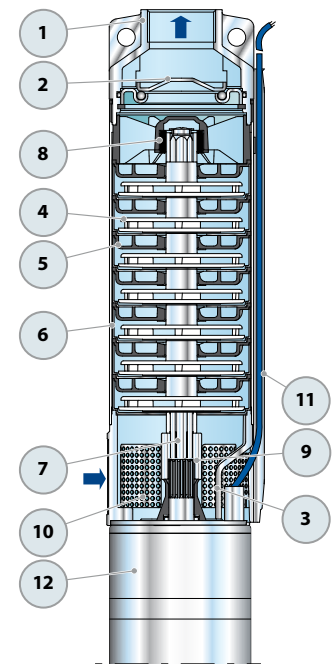

## STANDARD INSTALLATION

- 1) Submersible pump
- 2) Power cable clamps
- 3) Level probes; prevent dry running
- 4) Bracket and anchorage cable
- 5) Pressure gauge
- 6) Non-return valve
- 7) Gate valve; for flow rate regulation
- 8) Power cable
- 9) Control box
- 10) Pressure vessel
- 11) Pressure switch
- 12) Electro valve/electro-compressor

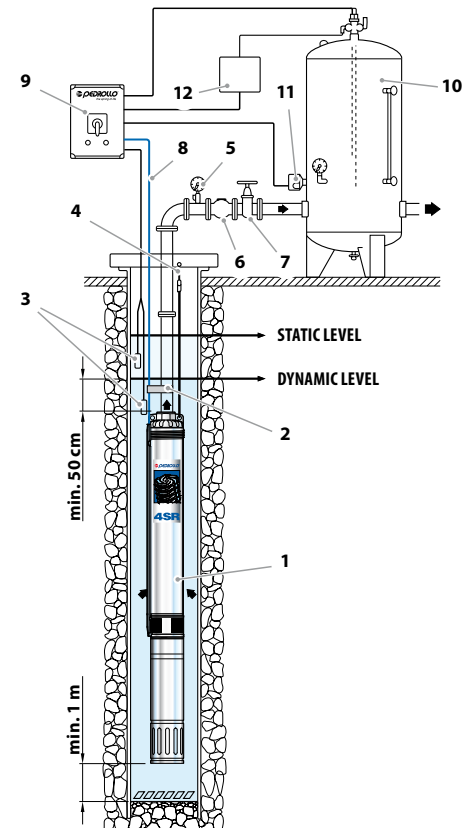
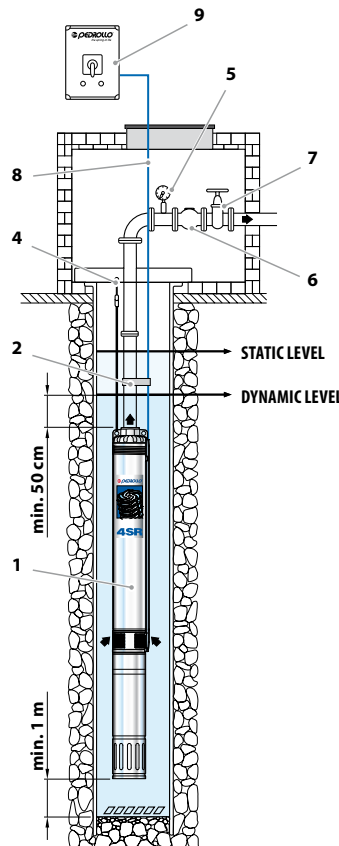

➡ The **4SR** series pumps should be installed in boreholes of at least 4" (100 mm) in diameter. The pump should be lowered into the borehole, by means of the delivery pipe, to such a depth (min. 50 cm and at least one metres from the bottom) that it is completely immersed during operation when the level of water in the borehole may reduce. It is good practice to secure the pump by attaching a stainless steel cable to the anchorage points present on the delivery body.

### DIMENSIONS AND WEIGHT

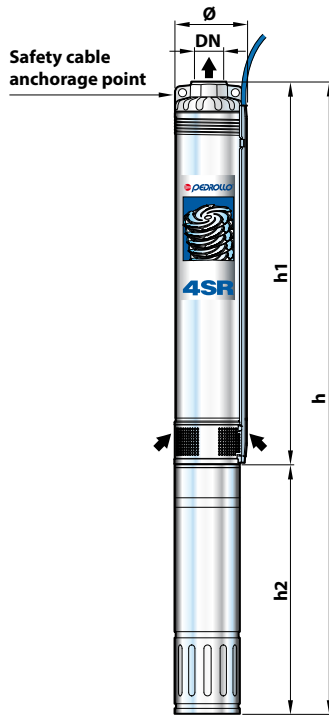

MODEL	PORT	DIMENSIONS mm				kg		
		DN	Ø	h1	h2		h	1~
<b>Single-phase</b>								
4SR1m/13 - PD	1 1/4"	98	400	311	711	11.2		
4SR1m/18 - PD			517	331	848	13.2		
4SR1m/25 - PD			646	356	1002	15.9		
4SR1m/35 - PD			856	396	1252	19.6		
4SR1m/45 - PD			1065	437	1502	23.1		
4SR1.5m/8 - PD			308	311	619	10.3		
4SR1.5m/13 - PD			400	331	731	11.7		
4SR1.5m/17 - PD			499	356	855	14.2		
4SR1.5m/25 - PD			646	396	1042	17.5		
4SR1.5m/32 - PD			800	437	1237	20.9		
4SR1.5m/46 - PD			1134	492	1626	28.1		
4SR2m/7 - PD			290	311	601	10.1		
4SR2m/10 - PD			345	331	676	11.4		
4SR2m/13 - PD			400	356	756	13.3		
4SR2m/20 - PD			554	396	950	16.6		
4SR2m/27 - PD			683	437	1120	19.5		
4SR2m/39 - PD			929	492	1421	25.4		
4SR4m/7 - PD			314	331	645	11.0		
4SR4m/9 - PD			358	356	714	12.8		
4SR4m/14 - PD			468	396	864	15.6		
4SR4m/18 - PD			580	437	1017	18.3		
4SR4m/26 - PD			756	492	1248	23.2		
4SR6m/4 - PD			2"	98	281	331	612	10.9
4SR6m/6 - PD					341	356	697	12.5
4SR6m/9 - PD					431	396	827	15.0
4SR6m/13 - PD					576	437	1013	17.8
4SR6m/17 - PD					695	492	1187	22.2
4SR8m/4 - PD					281	356	637	12.0
4SR8m/7 - PD	371	396			767	14.4		
4SR8m/9 - PD	431	437			868	16.4		
4SR8m/13 - PD	576	492			1068	21.0		
4SR10m/6 -N - PD	616	356			972	14.0		
4SR10m/8 -N - PD	762	396			1158	16.9		
4SR10m/11 -N - PD	981	437			1418	20.2		
4SR10m/16 -N - PD	1346	492			1838	26.4		
4SR12m/5 -N - PD	543	356			899	13.4		
4SR12m/7 -N - PD	689	396			1085	16.3		
4SR12m/9 -N - PD	835	437			1272	19.0		
4SR12m/14 -N - PD	1200	492	1692	25.2				
4SR15m/6 -N - PD	616	396	1012	15.7				
4SR15m/8 -N - PD	762	437	1199	18.4				
4SR15m/12 -N - PD	1054	492	1546	24.0				

MODEL	PORT	DIMENSIONS mm				kg		
		DN	Ø	h1	h2		h	3~
<b>Three-phase</b>								
4SR1/13 - PD	1 1/4"	98	400	311	711	11.2		
4SR1/18 - PD			517	331	848	13.2		
4SR1/25 - PD			646	356	1002	15.9		
4SR1/35 - PD			856	396	1227	18.8		
4SR1/45 - PD			1065	396	1461	21.6		
4SR1.5/8 - PD			308	311	619	10.3		
4SR1.5/13 - PD			400	331	731	11.7		
4SR1.5/17 - PD			499	356	855	14.2		
4SR1.5/25 - PD			646	371	1017	16.7		
4SR1.5/32 - PD			800	396	1196	19.4		
4SR1.5/46 - PD			1134	437	1571	24.9		
4SR2/7 - PD			290	311	601	10.1		
4SR2/10 - PD			345	331	676	11.4		
4SR2/13 - PD			400	356	756	13.3		
4SR2/20 - PD			554	371	925	15.8		
4SR2/27 - PD			683	396	1079	18.0		
4SR2/39 - PD			929	437	1366	22.2		
4SR4/7 - PD			314	331	645	11.0		
4SR4/9 - PD			358	356	714	12.8		
4SR4/14 - PD			468	371	839	14.8		
4SR4/18 - PD			580	396	976	16.8		
4SR4/26 - PD			756	437	1193	20.0		
4SR4/35 - PD			978	450	1428	23.9		
4SR4/46 - PD			1295	505	1800	31.1		
4SR4/60 - PD			1652	700	2352	44.1		
4SR6/4 - PD			2"	98	281	331	612	10.9
4SR6/6 - PD					341	356	697	12.5
4SR6/9 - PD					431	371	802	14.2
4SR6/13 - PD					576	396	972	16.3
4SR6/17 - PD					695	437	1132	19.0
4SR6/23 - PD					900	450	1350	22.5
4SR6/31 - PD					1164	505	1669	27.7
4SR6/42 - PD					1519	700	2219	40.4
4SR6/56 - PD					2063	800	2863	51.0
4SR8/4 - PD					281	356	637	12.0
4SR8/7 - PD					371	371	742	13.6
4SR8/9 - PD					431	396	827	14.9
4SR8/13 - PD					576	437	1013	17.8
4SR8/17 - PD					695	450	1145	20.4
4SR8/23 - PD					900	505	1405	25.4
4SR8/31 - PD					1164	700	1864	36.5
4SR8/42 - PD					1519	800	2319	43.9
4SR10/6 -N - PD					616	356	972	14.0
4SR10/8 -N - PD					762	371	1133	16.1
4SR10/11 -N - PD					981	396	1377	18.7
4SR10/16 -N - PD					1346	437	1783	23.2
4SR10/22 -N - PD	1784	450			2234	28.2		
4SR10/30 -N - PD	2368	505			2873	36.1		
4SR10/41 -N - PD	3171	700			3871	51.2		
4SR12/5 -N - PD	543	356	899	13.4				
4SR12/7 -N - PD	689	371	1060	15.5				
4SR12/9 -N - PD	835	396	1231	17.5				
4SR12/14 -N - PD	1200	437	1637	22.0				
4SR12/19 -N - PD	1565	450	2015	26.5				
4SR12/25 -N - PD	2003	505	2508	32.9				
4SR12/34 -N - PD	2660	700	3360	46.9				
4SR15/6 -N - PD	616	371	987	14.9				
4SR15/8 -N - PD	762	396	1158	16.9				
4SR15/12 -N - PD	1054	437	1491	20.8				
4SR15/16 -N - PD	1346	450	1796	24.7				
4SR15/21 -N - PD	1711	505	2216	30.5				
4SR15/29 -N - PD	2295	700	2995	43.9				

### DIMENSIONS AND WEIGHT

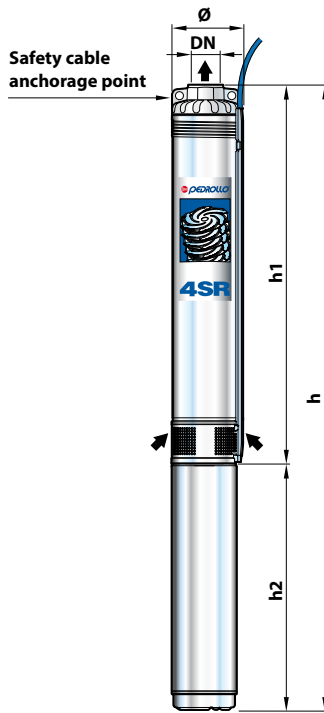

MODEL	PORT DN	DIMENSIONS mm			kg	
		Ø	h1	h2		h
<b>Single-phase</b>						
4SR1m/13 - PS	1 1/4"	98	400	237	637	11.5
4SR1m/18 - PS			517	257	774	13.9
4SR1m/25 - PS			646	272	918	16.5
4SR1m/35 - PS			856	312	1168	20.6
4SR1m/45 - PS			1065	352	1417	24.8
4SR1.5m/8 - PS			308	237	545	10.6
4SR1.5m/13 - PS			400	257	657	12.4
4SR1.5m/17 - PS			499	272	771	14.8
4SR1.5m/25 - PS			646	312	958	18.5
4SR1.5m/32 - PS			800	352	1152	22.6
4SR1.5m/46 - PS			1134	402	1536	27.4
4SR2m/7 - PS			290	237	527	10.4
4SR2m/10 - PS			345	257	602	12.1
4SR2m/13 - PS			400	272	672	13.9
4SR2m/20 - PS			554	312	866	17.6
4SR2m/27 - PS			683	352	1035	21.2
4SR2m/39 - PS			929	402	1331	24.7
4SR4m/7 - PS			314	257	571	11.7
4SR4m/9 - PS			358	272	630	13.4
4SR4m/14 - PS			468	312	780	16.6
4SR4m/18 - PS	580	352	932	20.0		
4SR4m/26 - PS	756	402	1158	22.5		
4SR6m/4 - PS	2"	98	281	257	538	11.6
4SR6m/6 - PS			341	272	613	13.1
4SR6m/9 - PS			431	312	743	16.0
4SR6m/13 - PS			576	352	928	19.5
4SR6m/17 - PS			695	402	1097	21.5
4SR8m/4 - PS			281	272	553	12.6
4SR8m/7 - PS			371	312	683	15.4
4SR8m/9 - PS			431	352	783	18.1
4SR8m/13 - PS			576	402	978	20.3
4SR10m/6 -N - PS			616	272	888	14.6
4SR10m/8 -N - PS			762	312	1074	17.9
4SR10m/11 -N - PS			981	352	1333	21.9
4SR10m/16 -N - PS	1346	402	1748	25.7		
4SR12m/5 -N - PS	543	272	815	14.0		
4SR12m/7 -N - PS	689	312	1001	17.3		
4SR12m/9 -N - PS	835	352	1187	20.7		
4SR12m/14 -N - PS	1200	402	1602	24.5		
4SR15m/6 -N - PS	616	312	928	16.7		
4SR15m/8 -N - PS	762	352	1114	20.1		
4SR15m/12 -N - PS	1054	402	1456	23.3		

MODEL	PORT DN	DIMENSIONS mm			kg			
		Ø	h1	h2		h		
<b>Three-phase</b>								
4SR1/13 - PS	1 1/4"	98	400	237	637	11.5		
4SR1/18 - PS			517	237	754	12.8		
4SR1/25 - PS			646	257	903	15.3		
4SR1/35 - PS			856	272	1128	18.5		
4SR1/45 - PS			1065	297	1362	22.6		
4SR1.5/8 - PS			308	237	545	10.6		
4SR1.5/13 - PS			400	237	637	11.3		
4SR1.5/17 - PS			499	257	756	13.6		
4SR1.5/25 - PS			646	272	918	16.4		
4SR1.5/32 - PS			800	297	1097	20.4		
4SR1.5/46 - PS			1134	352	1486	26.6		
4SR2/7 - PS			290	237	527	10.4		
4SR2/10 - PS			345	237	582	11.0		
4SR2/13 - PS			400	257	657	12.7		
4SR2/20 - PS			554	272	826	15.5		
4SR2/27 - PS			683	297	980	19.0		
4SR2/39 - PS			929	352	1281	23.9		
4SR4/7 - PS			314	237	551	10.6		
4SR4/9 - PS			358	257	615	12.2		
4SR4/14 - PS			468	272	740	14.5		
4SR4/18 - PS			580	297	877	17.8		
4SR4/26 - PS			756	352	1108	21.7		
4SR4/35 - PS			978	484	1462	24.0		
4SR4/46 - PS			1295	574	1869	38.4		
4SR4/60 - PS			1652	664	2316	47.2		
4SR6/4 - PS			2"	98	281	237	518	10.5
4SR6/6 - PS					341	257	598	11.9
4SR6/9 - PS					431	272	703	13.9
4SR6/13 - PS					576	297	873	17.3
4SR6/17 - PS					695	352	1047	20.7
4SR6/23 - PS	900	484			1384	22.6		
4SR6/31 - PS	1164	574			1738	35.0		
4SR6/42 - PS	1519	664			2183	43.5		
4SR6/56 - PS	2063	764			2827	53.4		
4SR8/4 - PS	281	257			538	11.4		
4SR8/7 - PS	371	272			643	13.3		
4SR8/9 - PS	431	297			728	15.9		
4SR8/13 - PS	576	352			928	19.5		
4SR8/17 - PS	695	484			1179	20.5		
4SR8/23 - PS	900	574			1474	32.7		
4SR8/31 - PS	1164	664			1828	39.6		
4SR8/42 - PS	1519	764			2283	46.3		
4SR10/6 -N - PS	616	257			873	13.4		
4SR10/8 -N - PS	762	272			1034	15.8		
4SR10/11 -N - PS	981	297			1278	19.7		
4SR10/16 -N - PS	1346	352			1698	24.9		
4SR10/22 -N - PS	1784	484			2268	28.3		
4SR10/30 -N - PS	2368	574			2942	43.4		
4SR10/41 -N - PS	3171	664			3835	54.3		
4SR12/5 -N - PS	543	257	800	12.8				
4SR12/7 -N - PS	689	272	961	15.2				
4SR12/9 -N - PS	835	297	1132	18.5				
4SR12/14 -N - PS	1200	352	1552	23.7				
4SR12/19 -N - PS	1565	484	2049	26.6				
4SR12/25 -N - PS	2003	574	2577	40.2				
4SR12/34 -N - PS	2660	664	3324	50.0				
4SR15/6 -N - PS	616	272	888	14.6				
4SR15/8 -N - PS	762	297	1059	17.9				
4SR15/12 -N - PS	1054	352	1406	22.5				
4SR15/16 -N - PS	1346	484	1830	24.8				
4SR15/21 -N - PS	1711	574	2285	37.8				
4SR15/29 -N - PS	2295	664	2959	47.0				

# 4SR-HYD

## DIMENSIONS AND WEIGHT (PUMP ONLY)



MODEL Pump	PORT DN	DIMENSIONS mm			kg
		Ø	h1	h	
4SR1/13 - HYD	1¼"	98	400	403	4.7
4SR1/18 - HYD			517	520	6.0
4SR1/25 - HYD			646	649	7.4
4SR1/35 - HYD			856	859	9.4
4SR1/45 - HYD			1065	1068	11.4
4SR1.5/8 - HYD			308	311	3.8
4SR1.5/13 - HYD			400	403	4.5
4SR1.5/17 - HYD			499	502	5.7
4SR1.5/25 - HYD			646	649	7.3
4SR1.5/32 - HYD			800	803	9.2
4SR1.5/46 - HYD			1134	1137	13.2
4SR2/7 - HYD			290	293	3.6
4SR2/10 - HYD			345	348	4.2
4SR2/13 - HYD			400	403	4.8
4SR2/20 - HYD			554	557	6.4
4SR2/27 - HYD			683	686	7.8
4SR2/39 - HYD			929	932	10.5
4SR4/7 - HYD			314	317	3.8
4SR4/9 - HYD			358	361	4.3
4SR4/14 - HYD			468	471	5.4
4SR4/18 - HYD			580	583	6.6
4SR4/26 - HYD			756	759	8.3
4SR4/35 - HYD			978	981	10.7
4SR4/46 - HYD			1295	1298	15.0
4SR4/60 - HYD	1652	1655	19.4		
4SR6/4 - HYD	2"	98	281	284	3.7
4SR6/6 - HYD			341	344	4.0
4SR6/9 - HYD			431	434	4.8
4SR6/13 - HYD			576	579	6.1
4SR6/17 - HYD			695	698	7.3
4SR6/23 - HYD			900	903	9.3
4SR6/31 - HYD			1164	1167	11.6
4SR6/42 - HYD			1519	1522	15.7
4SR6/56 - HYD			2063	2066	22.0
4SR8/4 - HYD			281	284	3.5
4SR8/7 - HYD			371	374	4.2
4SR8/9 - HYD			431	434	4.7
4SR8/13 - HYD	576	579	6.1		
4SR8/17 - HYD	695	698	7.2		
4SR8/23 - HYD	900	903	9.3		
4SR8/31 - HYD	1164	1167	11.8		
4SR8/42 - HYD	1519	1522	14.9		
4SR10/6 -N - HYD	616	619	5.5		
4SR10/8 -N - HYD	762	765	6.7		
4SR10/11 -N - HYD	981	984	8.5		
4SR10/16 -N - HYD	1346	1349	11.5		
4SR10/22 -N - HYD	1784	1787	15.0		
4SR10/30 -N - HYD	2368	2371	20.0		
4SR10/41 -N - HYD	3171	3174	26.5		
4SR12/5 -N - HYD	543	546	4.9		
4SR12/7 -N - HYD	689	692	6.1		
4SR12/9 -N - HYD	835	838	7.3		
4SR12/14 -N - HYD	1200	1203	10.3		
4SR12/19 -N - HYD	1565	1568	13.3		
4SR12/25 -N - HYD	2003	2006	16.8		
4SR12/34 -N - HYD	2660	2663	22.2		
4SR15/6 -N - HYD	616	619	5.5		
4SR15/8 -N - HYD	762	765	6.7		
4SR15/12 -N - HYD	1054	1057	9.1		
4SR15/16 -N - HYD	1346	1349	11.5		
4SR15/21 -N - HYD	1711	1714	14.4		
4SR15/29 -N - HYD	2295	2298	19.2		